

# 4

## **BATTISCOPIA E FINITURE D'INTERNI**

Battiscopa e coprifili per porte

Cornici e coprispigoli

Sistemi a doghe per boiserie

Perlinati e pavimenti in Abete

Profili in PVC

# Battiscopa in Ayous

Legno massello. Aste da cm 240

A1

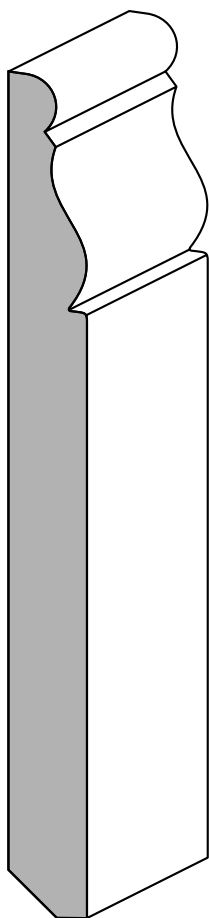

**TUDOR**  
**Battiscopa in Ayous**  
mm 140x13x2400

Codice	Colore	Pz Conf
<b>P1303</b>	Lacc. Bianco	6
<b>P3723</b>	Grezzo	6

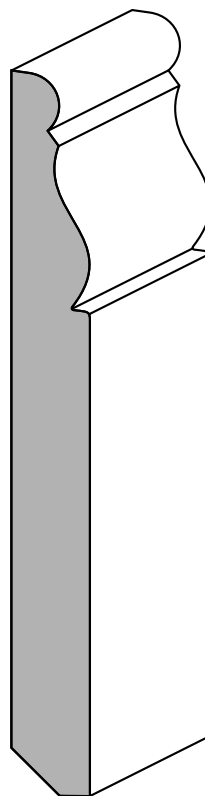

**TUDOR**  
**Battiscopa in Ayous**  
mm 120x13x2400

Codice	Colore	Pz Conf
<b>P1302</b>	Lacc. Bianco	6
<b>P3722</b>	Grezzo	6

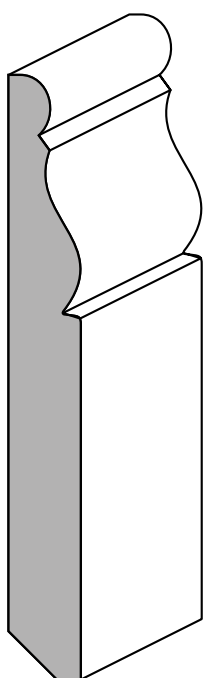

**TUDOR**  
**Battiscopa in Ayous**  
mm 100x12x2400

Codice	Colore	Pz Conf
<b>P1301</b>	Lacc. Bianco	6
<b>P3721</b>	Grezzo	6

# Battiscopa in Ayous

Legno massello. Aste da cm 240

A1

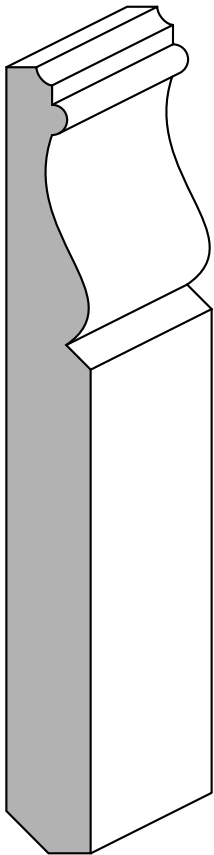

**TRADITION**  
**Battiscopa in Ayous**  
 mm 130x14x2400

Codice	Colore	Pz Conf
<b>P1304</b>	Lacc. Bianco	6
<b>P3724</b>	Grezzo	6

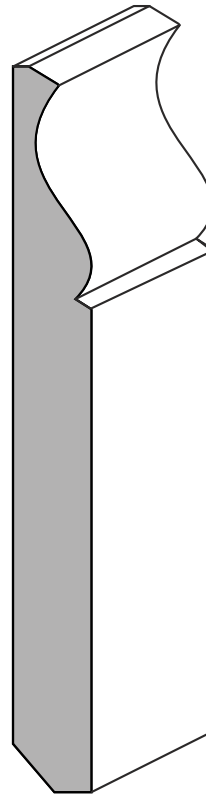

**OXFORD**  
**Battiscopa in Ayous**  
 mm 120x13x2400

Codice	Colore	Pz Conf
<b>P1329</b>	Lacc. Bianco	6
<b>P3725</b>	Grezzo	6

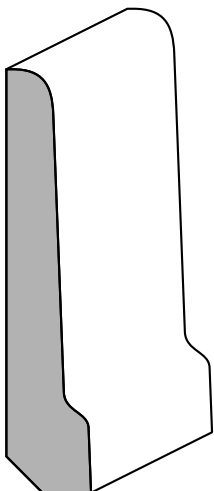

**Battiscopa in Ayous**  
 mm 70x14x2400

Codice	Colore	Pz Conf
<b>P1860</b>	Noce scuro	10
<b>P1861</b>	Noce chiaro	10
<b>P1862</b>	Mogano	10
<b>P1893</b>	Rovere	10
<b>P1864</b>	Lacc. Bianco	10
<b>P3860</b>	Grezzo	10

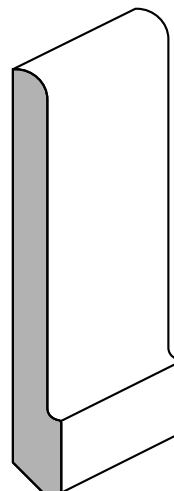

**Battiscopa in Ayous**  
 mm 70x8x2400

Codice	Colore	Aste
<b>P1850</b>	Noce scuro	10
<b>P1851</b>	Noce chiaro	10
<b>P1875</b>	Rovere	10
<b>P1854</b>	Lacc. Bianco	10
<b>P3850</b>	Grezzo	10

# Battiscopa in Ayous

Legno massello. Aste da cm 240

A1

**Linea FLAT**  
Design contemporaneo

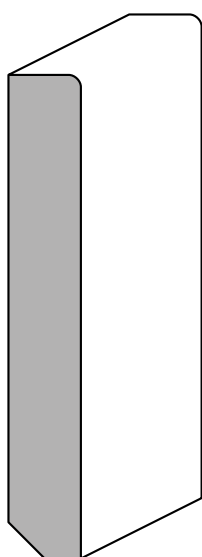
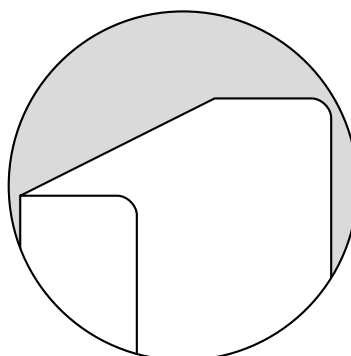

**FLAT**  
**Battiscopa in Ayous**  
mm 80x12x2400

Codice	Colore	Pz Conf
<b>P1702</b>	Lacc. Bianco	10
<b>P3702</b>	Grezzo	10

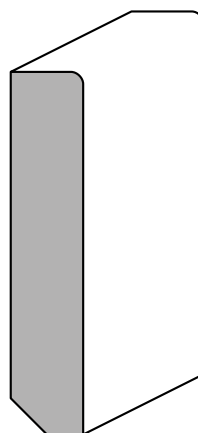

**FLAT**  
**Battiscopa in Ayous**  
mm 60x12x2400

Codice	Colore	Pz Conf
<b>P1701</b>	Lacc. Bianco	10
<b>P3701</b>	Grezzo	10

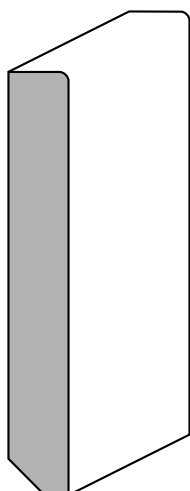

**FLAT**  
**Battiscopa in Ayous**  
mm 70x10x2400

Codice	Colore	Pz Conf
<b>P1703</b>	Lacc. Bianco	10
<b>P3703</b>	Grezzo	10

Spessore ideale per nascondere il vuoto di pavimenti in laminato e vinilici

I battiscopa squadri FLAT sono disponibili anche in MDF

# Battiscopa in Ayous

Legno massello. Aste da cm 240

A1

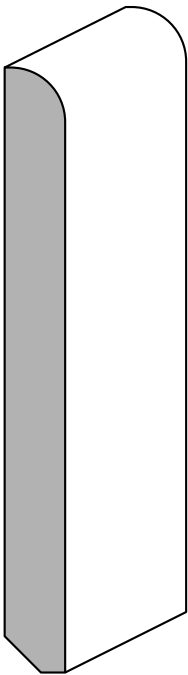

**Battiscopa in Ayous**  
mm 100x10x2400

Codice	Colore	Pz Conf
<b>P1710</b>	Noce scuro	10
<b>P1711</b>	Noce chiaro	10
<b>P1716</b>	Lacc. Bianco	10
<b>P3710</b>	Grezzo	10

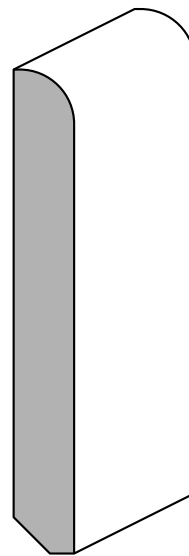

**Battiscopa in Ayous**  
mm 80x10x2400

Codice	Colore	Pz Conf
<b>P1795</b>	Noce scuro	10
<b>P1796</b>	Noce chiaro	10
<b>P1797</b>	Mogano	10
<b>P1799</b>	Rovere	10
<b>P1774</b>	Ciliegio	10
<b>P1792</b>	Lacc. Bianco	10
<b>P3795</b>	Grezzo	10

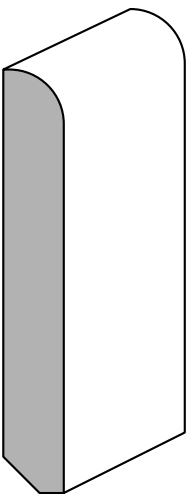

**Battiscopa in Ayous**  
mm 70x10x2400

Codice	Colore	Pz Conf
<b>P1865</b>	Noce scuro	10
<b>P1866</b>	Noce chiaro	10
<b>P1867</b>	Mogano	10
<b>P1870</b>	Rovere	10
<b>P1719</b>	Ciliegio	10
<b>P1869</b>	Lacc. Bianco	10
<b>P3865</b>	Grezzo	10

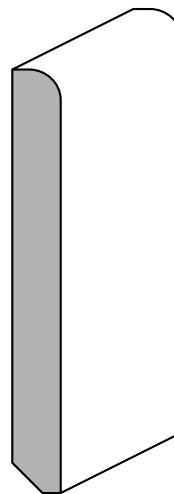

**Battiscopa in Ayous**  
mm 70x8x2400

Codice	Colore	Pz Conf
<b>P1855</b>	Noce scuro	10
<b>P1856</b>	Noce chiaro	10
<b>P1857</b>	Mogano	10
<b>P1876</b>	Rovere	10
<b>P1859</b>	Lacc. Bianco	10
<b>P3855</b>	Grezzo	10

# Battiscopa in Ayous

Legno massello. Aste da cm 240

A1

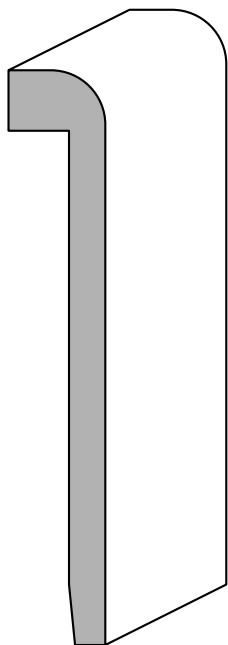

## Copribattiscopa in Ayous

mm 95x16x2400

Codice	Colore	Pz Conf
<b>P1545</b>	Lacc. Bianco	10
<b>P3642</b>	Grezzo	10

Scavo interno mm 85x10

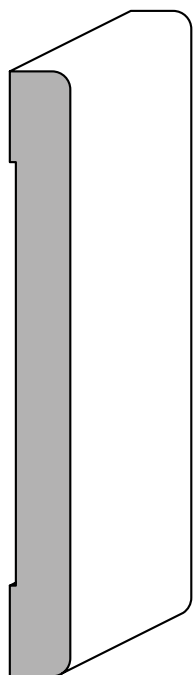

## Fascia salvaparete in Ayous

mm 100x10x2400

Codice	Colore	Pz Conf
<b>P1506</b>	Lacc. Bianco	10
<b>P1509</b>	Grezzo	10

# Coprifili in Ayous

Legno massello. Aste da cm 225

A7

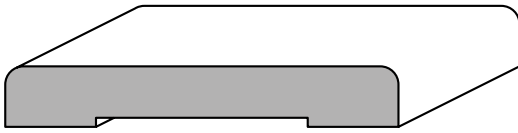

## Coprifilo in Ayous

mm 65x10x2250

Codice	Colore	Pz Conf
<b>P1785</b>	Noce scuro	10
<b>P1786</b>	Noce chiaro	10
<b>P1787</b>	Mogano	10
<b>P1784</b>	Ciliegio	10
<b>P1789</b>	Rovere	10
<b>P1791</b>	Lacc. Bianco	10
<b>P3785</b>	Grezzo	10

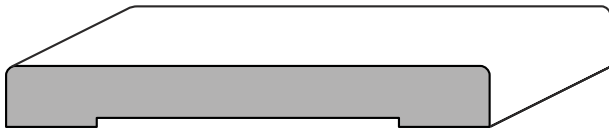

## FLAT

## Coprifilo in Ayous

mm 80x10x2250

Codice	Colore	Pz Conf
<b>P1354</b>	Laccato bianco	10
<b>P3751</b>	Grezzo	10

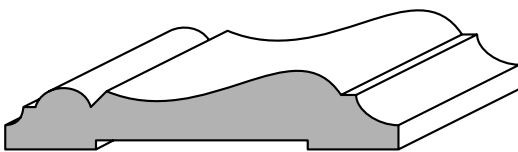

## Coprifilo in Ayous

mm 65x12x2250

Codice	Colore	Pz Conf
<b>P1781</b>	Lacc. Bianco	10
<b>P3771</b>	Grezzo	10

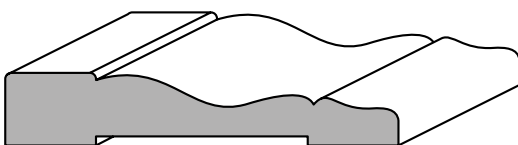

## Coprifilo in Ayous

mm 65x12x2250

Codice	Colore	Pz Conf
<b>P3730</b>	Grezzo	10

# Coprispigoli in Ayous

A2

Legno massello. Aste da cm 300

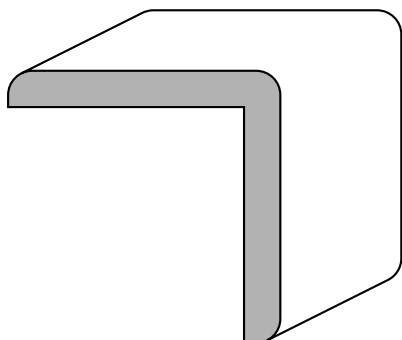

**Coprispigolo in Ayous**  
mm 45x45x3000

Codice	Colore	Pz Conf
<b>P1840</b>	Noce scuro	20
<b>P1841</b>	Noce chiaro	20
<b>P1842</b>	Mogano	20
<b>P1843</b>	Lacc. Bianco	20
<b>P3840</b>	Grezzo	20

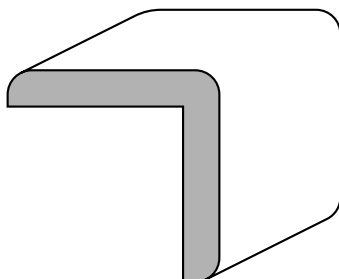

**Coprispigolo in Ayous**  
mm 35x35x3000

Codice	Colore	Pz Conf
<b>P1745</b>	Noce scuro	20
<b>P1746</b>	Noce chiaro	20
<b>P1747</b>	Mogano	20
<b>P1743</b>	Lacc. Bianco	20
<b>P3745</b>	Grezzo	20

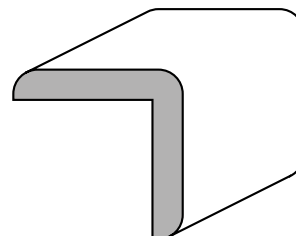

**Coprispigolo in Ayous**  
mm 28x28x3000

Codice	Colore	Pz Conf
<b>P1835</b>	Noce scuro	20
<b>P1836</b>	Noce chiaro	20
<b>P1837</b>	Mogano	20
<b>P1892</b>	Rovere	20
<b>P1895</b>	Ciliegio	20
<b>P1839</b>	Lacc. Bianco	20
<b>P3835</b>	Grezzo	20

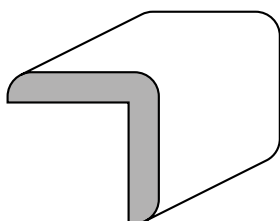

**Coprispigolo in Ayous**  
mm 25x25x3000

Codice	Colore	Pz Conf
<b>P1765</b>	Noce scuro	20
<b>P1766</b>	Noce chiaro	20
<b>P1767</b>	Mogano	20
<b>P1769</b>	Rovere	20
<b>P1770</b>	Ciliegio	20
<b>P1771</b>	Lacc. Bianco	20
<b>P3765</b>	Grezzo	20

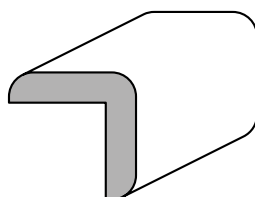

**Coprispigolo in Ayous**  
mm 21x21x3000

Codice	Colore	Pz Conf
<b>P1820</b>	Noce scuro	20
<b>P1821</b>	Noce chiaro	20
<b>P1822</b>	Mogano	20
<b>P1894</b>	Rovere	20
<b>P1844</b>	Ciliegio	20
<b>P1824</b>	Lacc. Bianco	20
<b>P3820</b>	Grezzo	20

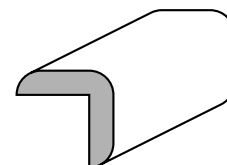

**Coprispigolo in Ayous**  
mm 16x16x3000

Codice	Colore	Pz Conf
<b>P1560</b>	Lacc. Bianco	20
<b>P3556</b>	Grezzo	20



## Coprispigoli in Ayous

Legno massello. Aste da cm 300

A2

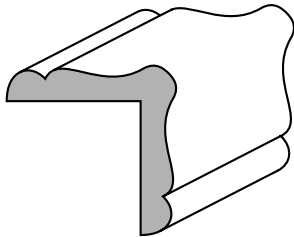

**Coprispigolo in Ayous**  
mm 28x28x3000

Codice	Colore	Pz Conf
<b>P1830</b>	Noce scuro	20
<b>P1834</b>	Lacc. Bianco	20

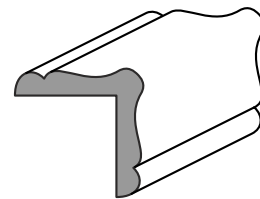

**Coprispigolo in Ayous**  
mm 21x21x3000

Codice	Colore	Pz Conf
<b>P1826</b>	Noce chiaro	20
<b>P1829</b>	Lacc. Bianco	20
<b>P3825</b>	Grezzo	20

## Coprispigoli FLAT in Ayous

Legno massello. Aste da cm 300

A2

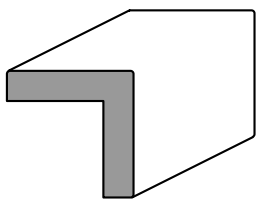

**FLAT**  
**Coprispigolo in Ayous**  
mm21x21x3000

Codice	Colore	Pz Conf
<b>P1847</b>	Lacc. Bianco	20
<b>P3847</b>	Grezzo	20

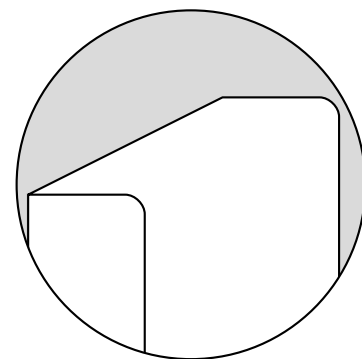

**Linea FLAT**  
Design contemporaneo

## Coprispigoli in Ayous

A21

Legno massello. Aste da cm 240 Disponibilità salvo venduto

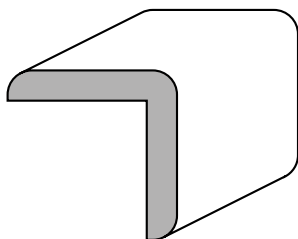

**Coprispigolo in Ayous**  
mm 28x28x**2400\***

Codice	Colore	Pz Conf
<b>P11835</b>	Noce scuro	20
<b>P11836</b>	Noce chiaro	20
<b>P11839</b>	Lacc. Bianco	20
<b>P33835</b>	Grezzo	20

\* Se non disponibile saranno forniti in aste da cm 200 con adeguamento del prezzo

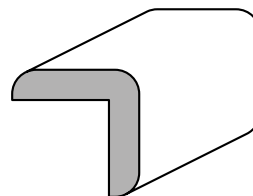

**Coprispigolo in Ayous**  
mm 21x21x**2400\***

Codice	Colore	Pz Conf
<b>P11820</b>	Noce scuro	20
<b>P11821</b>	Noce chiaro	20
<b>P11824</b>	Lacc. Bianco	20
<b>P33820</b>	Grezzo	20

\* Se non disponibile saranno forniti in aste da cm 200 con adeguamento del prezzo

## Angolari in Ayous

A6

Legno massello. Aste da cm 300

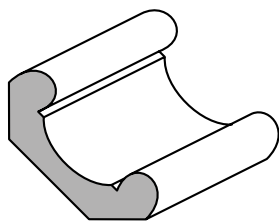

**Angolare in Ayous**  
mm 32x12x3000

Codice	Colore	Pz Conf
<b>P1671</b>	Lacc. Bianco	20
<b>P3673</b>	Grezzo	20

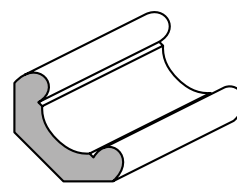

**Angolare in Ayous**  
mm 23x10x3000

Codice	Colore	Pz Conf
<b>P1755</b>	Noce scuro	20
<b>P1756</b>	Noce chiaro	20
<b>P1757</b>	Mogano	20
<b>P1759</b>	Rovere	20
<b>P1761</b>	Lacc. Bianco	20
<b>P3755</b>	Grezzo	20

# Terminali in Ayous

Legno massello

A8

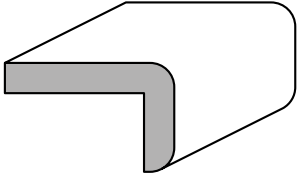

## Terminale in Ayous

mm 28x18x2400

Codice	Colore	Pz Conf
<b>P1655</b>	Lacc. Bianco	20
<b>P3649</b>	Grezzo	20

Interno mm 22x12

# Quarti di tondo in Ayous

Legno massello

A4

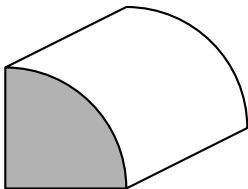

## Quarto di tondo in Ayous

mm 20x20x3000

Codice	Colore	Pz Conf
<b>P1531</b>	Lacc. Bianco	20
<b>P3869</b>	Grezzo	20

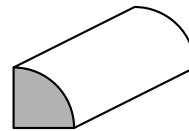

## Quarto di tondo in Ayous

mm 10x10x3000

Codice	Colore	Pz Conf
<b>P1679</b>	Noce scuro	20
<b>P1680</b>	Noce chiaro	20
<b>P1683</b>	Rovere	20
<b>P1684</b>	Lacc. Bianco	20
<b>P1879</b>	Grezzo	20

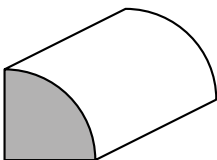

## Quarto di tondo in Ayous

mm 15x15x3000

Codice	Colore	Pz Conf
<b>P1516</b>	Noce scuro	20
<b>P1517</b>	Noce chiaro	20
<b>P1520</b>	Rovere	20
<b>P1522</b>	Lacc. Bianco	20
<b>P3859</b>	Grezzo	20

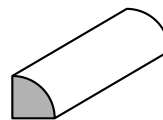

## Quarto di tondo in Ayous

mm 7x7x3000

Codice	Colore	Pz Conf
<b>P3801</b>	Grezzo	20

# Cornici in Ayous

A3

Legno massello

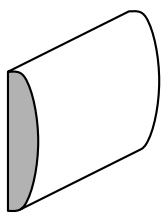

**Profilo in Ayous**  
mm 23x5x2000/2400\*

Codice cm 200	Codice cm 240	Colore	Conf
<b>P1648</b>	<b>P1618</b>	Lacc. Bianco	50
<b>P3643</b>	<b>P3618</b>	Grezzo	50

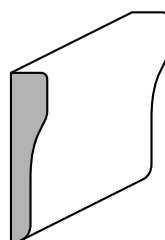

**Profilo in Ayous**  
mm 28x6x2000/2400\*

Codice cm 200	Codice cm 240	Colore	Conf
<b>P1814</b>	<b>P1873</b>	Lacc. Bianco	50
<b>P3810</b>	<b>P3873</b>	Grezzo	50

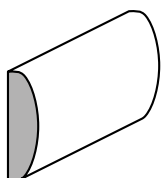

**Profilo in Ayous**  
mm 18x5x2000/2400\*

Codice cm 200	Codice cm 240	Colore	Conf
<b>P1805</b>	<b>P1637</b>	Noce scuro	50
<b>P1806</b>	<b>P1638</b>	Noce chiaro	50
<b>P1807</b>	<b>P1639</b>	Mogano	50
<b>P1706</b>	<b>P1640</b>	Ciliegio	50
<b>P1809</b>	<b>P1641</b>	Lacc. Bianco	50
<b>P3805</b>	<b>P3637</b>	Grezzo	50

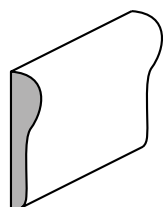

**Profilo in Ayous**  
mm 23x5x2000/2400\*

Codice cm 200	Codice cm 240	Colore	Conf
<b>P1819</b>	<b>P1848</b>	Lacc. Bianco	50
<b>P3815</b>	<b>P3848</b>	Grezzo	50

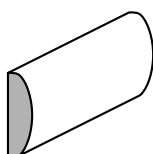

**Profilo in Ayous**  
mm 14x4x2000/2400\*

Codice cm 200	Codice cm 240	Colore	Conf
<b>P1800</b>	<b>P1685</b>	Noce scuro	50
<b>P1801</b>	<b>P1687</b>	Noce chiaro	50
<b>P1802</b>	<b>P1688</b>	Mogano	50
<b>P1804</b>	<b>P1689</b>	Lacc. Bianco	50
<b>P3800</b>	<b>P3684</b>	Grezzo	50

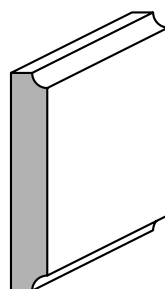

**Profilo in Ayous**  
mm 36x6x2000/2400\*

Codice cm 200	Codice cm 240	Colore	Conf
<b>P1626</b>	<b>P1629</b>	Lacc. Bianco	25
<b>P3621</b>	<b>P3620</b>	Grezzo	25

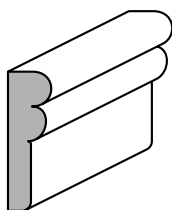

**Profilo in Ayous**  
mm 23x7x2000/2400\*

Codice cm 200	Codice cm 240	Colore	Conf
<b>P1697</b>	<b>P1698</b>	Lacc. Bianco	50
<b>P3792</b>	<b>P3689</b>	Grezzo	50

# Cornici in Ayous

Legno massello

A3

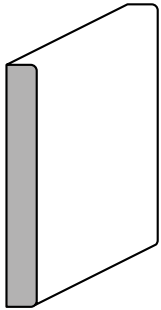

## Profilo in Ayous mm 40x5x2400

Codice	Colore	Pz Conf
<b>P1591</b>	Noce scuro	25
<b>P1592</b>	Noce chiaro	25
<b>P1593</b>	Mogano	25
<b>P1597</b>	Lacc. Bianco	25
<b>P3864</b>	Grezzo	25

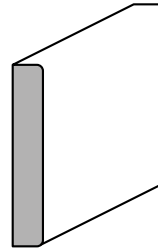

## Profilo in Ayous mm 30x5x2400

Codice	Colore	Pz Conf
<b>P1581</b>	Noce scuro	50
<b>P1582</b>	Noce chiaro	50
<b>P1583</b>	Mogano	50
<b>P1585</b>	Rovere	50
<b>P1587</b>	Lacc. Bianco	50
<b>P3863</b>	Grezzo	50

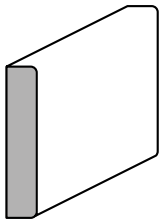

## Profilo in Ayous mm 25x5x2400

Codice	Colore	Pz Conf
<b>P1571</b>	Noce scuro	50
<b>P1572</b>	Noce chiaro	50
<b>P1577</b>	Lacc. Bianco	50
<b>P3862</b>	Grezzo	50

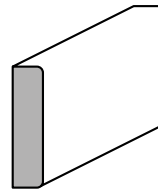

## Profilo in Ayous mm 20x5x2400

Codice	Colore	Pz Conf
<b>P1561</b>	Noce scuro	50
<b>P1562</b>	Noce chiaro	50
<b>P1563</b>	Mogano	50
<b>P1567</b>	Lacc. Bianco	50
<b>P3861</b>	Grezzo	50

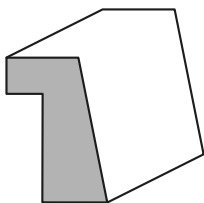

## Fermavetro in Ayous mm 24x14x2400

Codice	Colore	Pz Conf
<b>P3793</b>	Grezzo	20

Interno mm 18x6

## Cornici per boiserie

60B

Cornici riverniciabili per la decorazione di pareti e mobili  
Legno Ayous massello



**Cornice**  
mm 23x10x2000

Codice	Colore	Pz Conf
<b>13831</b>	Grezzo	50



**Cornice**  
mm 25x10x2400

Codice	Colore	Pz Conf
<b>13906</b>	Grezzo	50

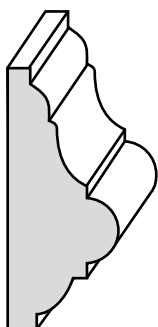

**Cornice**  
mm 35x15x2400

Codice	Colore	Pz Conf
<b>13908</b>	Grezzo	25

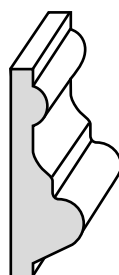

**Cornice**  
mm 28x10x2400

Codice	Colore	Pz Conf
<b>13907</b>	Grezzo	25

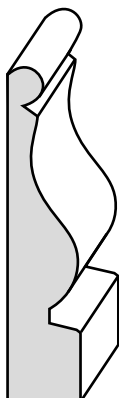

**Cornice**  
mm 45x10x2400

Codice	Colore	Pz Conf
<b>13909</b>	Grezzo	25

# Cornici per boiserie

60B

Cornici riverniciabili per la decorazione di pareti e mobili  
Legno Ayous massello

## Come decorare le pareti

Le cornici in legno ayous si possono incollare su pareti o mobili per creare le decorazione tipiche delle boiserie classiche.

Si possono posare anche grezze e verniciare con lo stesso prodotto murale utilizzato per le pareti.

Il legno, a differenza del polistirolo o del poliuretano, è più resistente e si vernicia facilmente. La percezione di qualità è maggiore rispetto a materiali "sintetici"

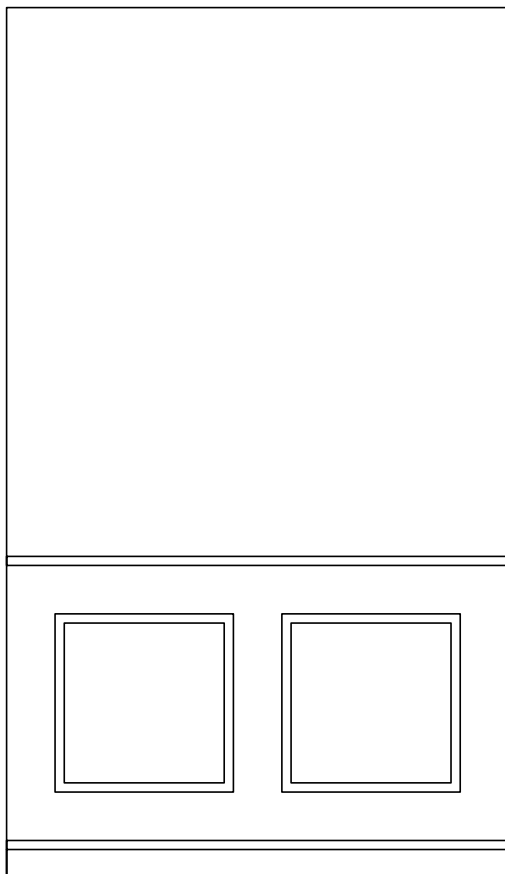

Battiscopa  
Cornice orizzontale  
Riquadri

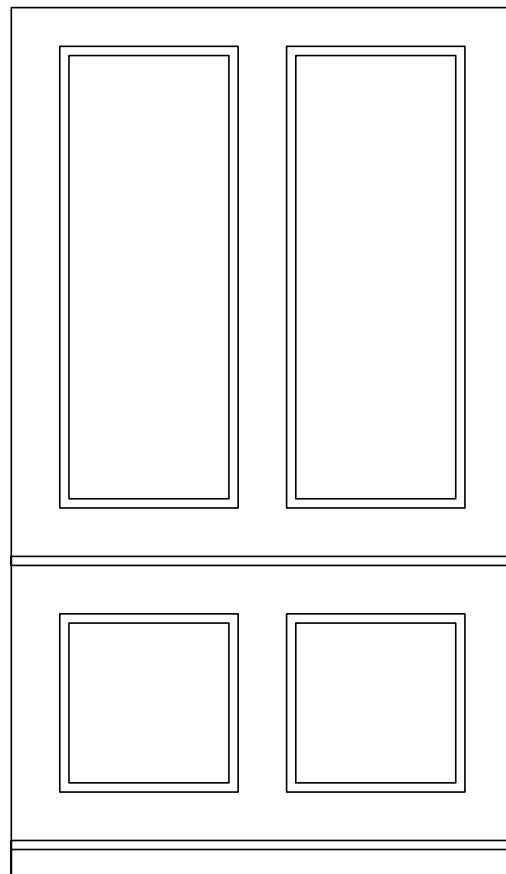

Battiscopa  
Cornice orizzontale  
Doppi riquadri

# Boiserie DECORA

A3

Cornici riverniciabili per la decorazione di pareti e mobili  
Legno Ayous massello

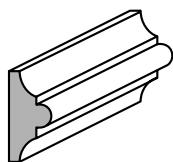

## Profilo in Ayous

mm 15x7x2000/**2400\***

Codice cm 200	Codice cm 240	Colore	Conf
<b>P3794</b>	<b>P3797</b>	Grezzo	50

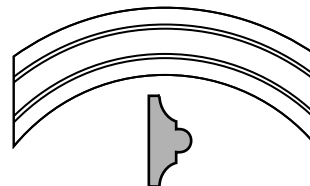

## Archetto in Ayous

mm 15x7x80

Codice	Colore	Pz Conf
<b>2033</b>	Grezzo	1



# Battiscopa e coprifili in MDF

M1

Laccati opaco finitura poro chiuso

**Linea FLAT**  
design contemporaneo

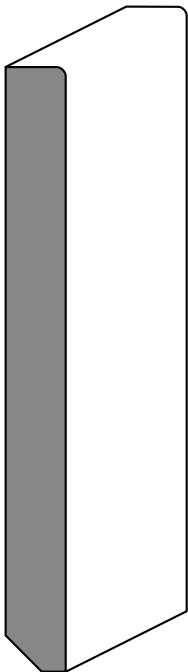
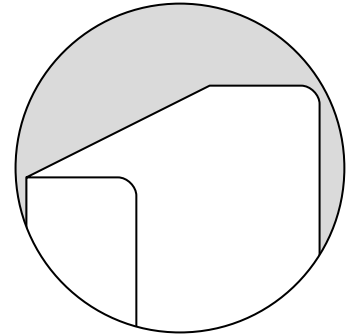

**FLAT**  
**Battiscopa in MDF**  
mm 100x10x2200

Codice	Colore	Pz Conf
<b>P6410</b>	Lacc. Bianco	10

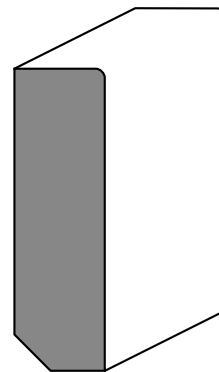

**FLAT**  
**Battiscopa in MDF**  
mm 50x12x2200

Codice	Colore	Pz Conf
<b>P6416</b>	Lacc. Bianco	10

Spessore idoneo per nascondere il vuoto di dilatazione di pavimenti

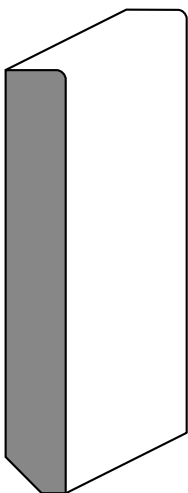

**FLAT**  
**Battiscopa in MDF**  
mm 70x10x2200

Codice	Colore	Pz Conf
<b>P6404</b>	Lacc. Bianco	10

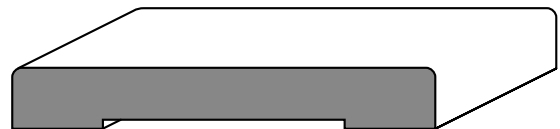

**Coprifilo FLAT**  
mm 70x10x2250

**FLAT**  
**Battiscopa in MDF**  
mm 50x10x2200

Codice	Colore	Pz Conf
<b>P6415</b>	Lacc. Bianco	10

Codice	Colore	Pz Conf
<b>P7320</b>	Lacc. Bianco	10

I battiscopa squadrati FLAT sono disponibili anche in Ayous massello

# Battiscopa e coprifili in MDF

M1

Laccati opaco finitura poro chiuso

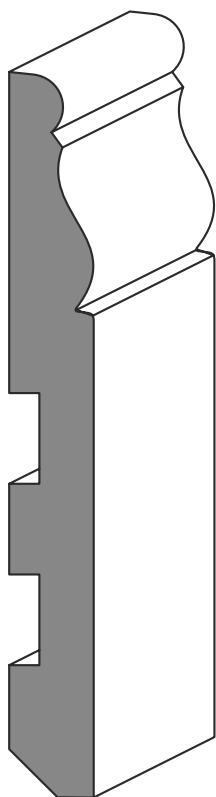

**TUDOR**  
**Battiscopa in MDF**  
mm 120x14x2200

Codice	Colore	Pz Conf
<b>P6430</b>	Lacc. Bianco	6

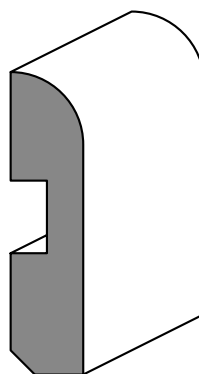

**BERLINO**  
**Battiscopa in MDF**  
mm 50x12x2200

Codice	Colore	Pz Conf
<b>P6435</b>	Lacc. Bianco	10

Con canale passafilo

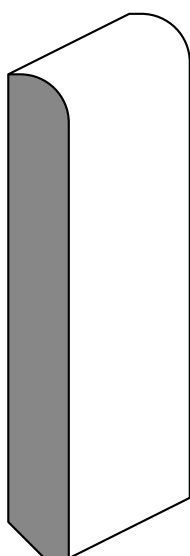

**CLASSIC**  
**Battiscopa in MDF**  
mm 80x10x2200

Codice	Colore	Pz Conf
<b>P6221</b>	Lacc. Bianco	10

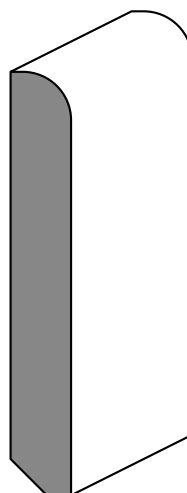

**CLASSIC**  
**Battiscopa in MDF**  
mm 70x10x2200

Codice	Colore	Pz Conf
<b>P6407</b>	Lacc. Bianco	10
<b>P6405</b>	Nero Serico	10

## Boiserie in MDF

M1

Profili grezzi e laccati per il rivestimento delle pareti

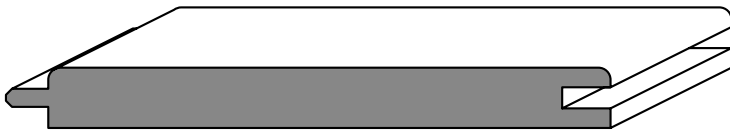

**Perlina in MDF**  
mm 100x10x2200  
parte visibile mm 93

Codice	Colore
<b>P6703</b>	Grezzo
<b>P6704</b>	Lacc. Bianco

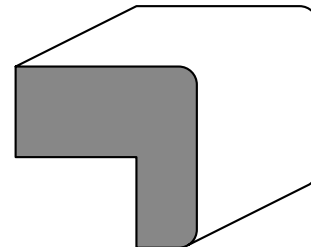

**Terminale in MDF**  
mm 30x30x2200  
scavo interno mm 20x15

Codice	Colore	Pz Conf
<b>P8705</b>	Grezzo	10
<b>P6705</b>	Lacc. Bianco	10

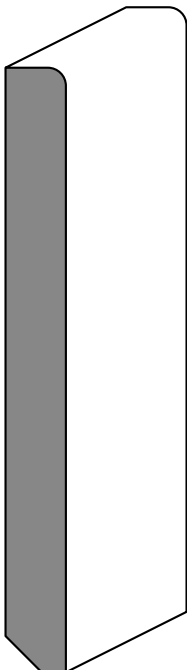

**FLAT**  
**Battiscopa in MDF**  
mm 100x10x2200

Codice	Colore	Pz Conf
<b>P6410</b>	Lacc. Bianco	10

**Listello in Abete piallato**  
mm 10x40x2000

Codice	Colore	Pz Conf
<b>29663</b>	Grezzo	15

## Boiserie in MDF

M1

Profili grezzi e laccati per il rivestimento delle pareti

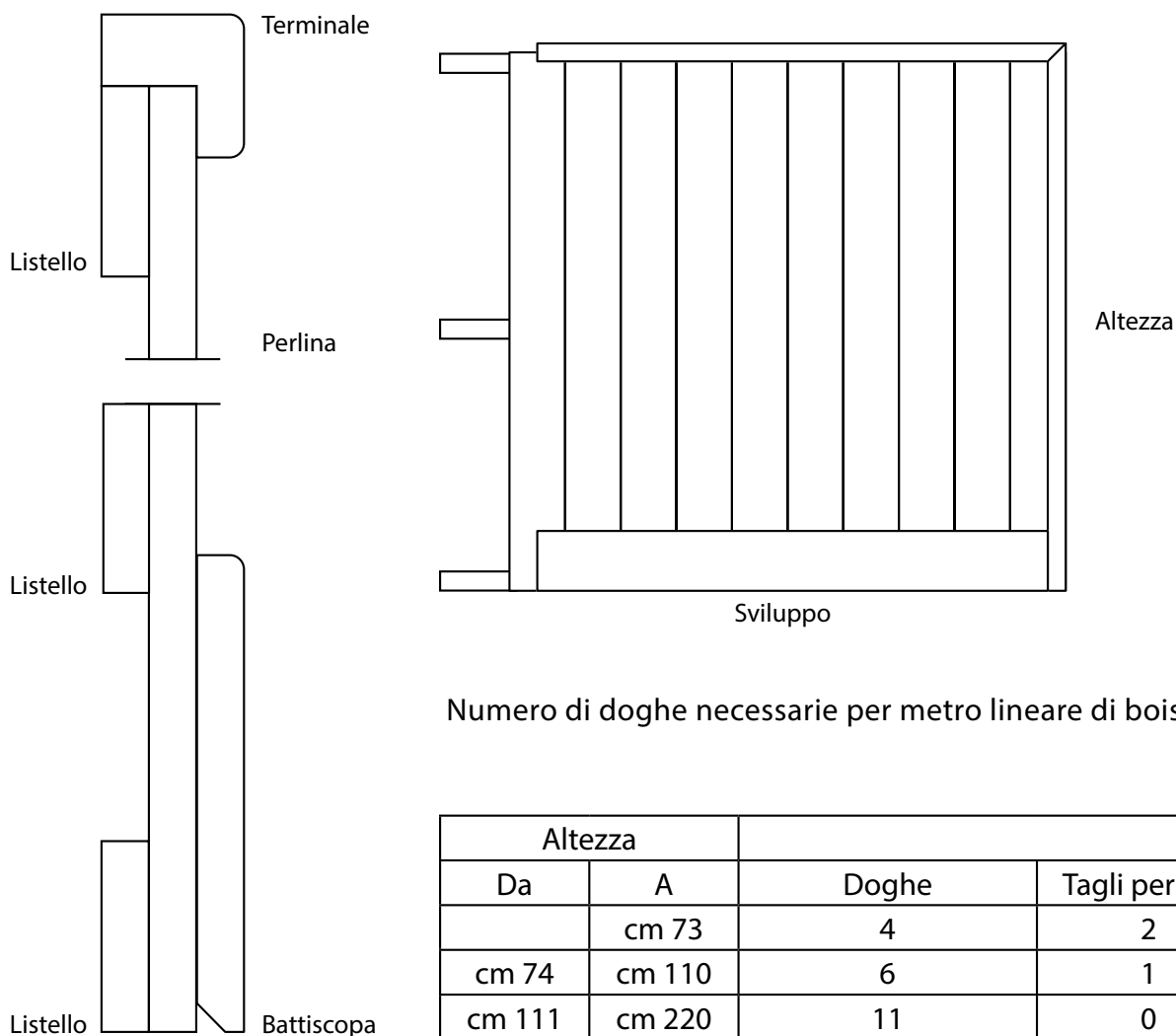

### Consigli e suggerimenti:

I profili grezzi possono essere verniciati a spruzzo o a pennello prima della posa  
 Riducendo la profondità del terminale le doghe possono essere incollate direttamente a parete  
 Laccatura Ral al campione ordine minimo 40 pacchi di perlina

# LEGNI PREGIATI

N1

Battiscopa e coprifili impiallacciati in vero legno  
Verniciatura trasparente

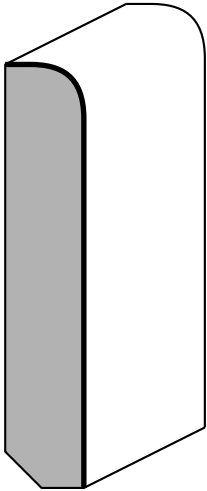

**Battiscopa**  
mm **80**x13x2400

Codice	Colore	Pz Conf
<b>P14882</b>	Rovere	10

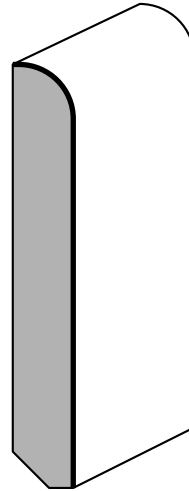

**Battiscopa**  
mm 70x10x2400

Codice	Colore	Pz Conf
<b>P14051</b>	Rovere	10
<b>P14056</b>	Mogano	10
<b>P14062</b>	Tanganika noce	10



**Coprifilo**  
mm 70x10x2250

Codice	Colore	Pz Conf
<b>P20051</b>	Rovere	10
<b>P20056</b>	Mogano	10
<b>P20063</b>	Ciliegio	10

# TANGANIKA

N5

Battiscopa e coprifili impiallacciati in Tanganika selezionato

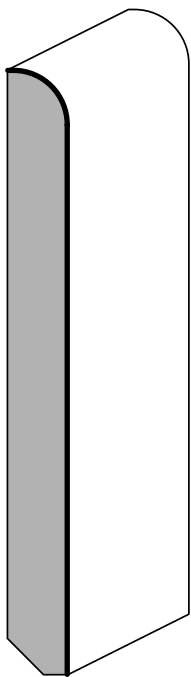

**Battiscopa Tanganika**  
mm 100x10x2400

Codice	Colore	Pz Conf
<b>P1444</b>	Lacc. Bianco	10
<b>P8440</b>	Grezzo	10

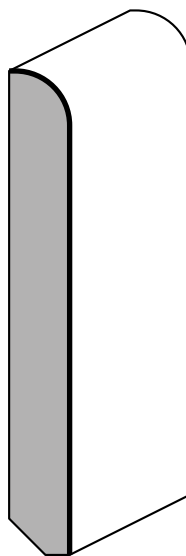

**Battiscopa Tanganika**  
mm 80x10x2400

Codice	Colore	Pz Conf
<b>P1410</b>	Noce sc.	10
<b>P1411</b>	Noce ch.	10
<b>P1412</b>	Mogano	10
<b>P1413</b>	Rovere	10
<b>P1414</b>	Lacc. Bianco	10
<b>P8409</b>	Grezzo	10

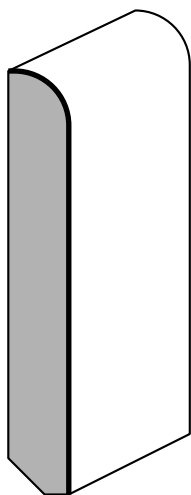

**Battiscopa Tanganika**  
mm 70x10x2400

Codice	Colore	Pz Conf
<b>P14053</b>	Naturale	10
<b>P1405</b>	Noce sc.	10
<b>P1406</b>	Noce ch.	10
<b>P1407</b>	Mogano	10
<b>P1408</b>	Rovere	10
<b>P1409</b>	Lacc. Bianco	10
<b>P8404</b>	Grezzo	10

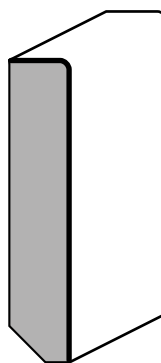

**FLAT**  
**Battiscopa Tanganika**  
mm 50x10x2400

Codice	Colore	Pz Conf
<b>P1446</b>	Lacc. Bianco	10

# TANGANIKA

N5

Coprifili impiallacciati in Tanganika selezionato



## Coprifilo Tanganika

mm 70x10x2250

Codice	Colore	Pz Conf
<b>P20053</b>	Naturale	10
<b>P1425</b>	Noce sc.	10
<b>P1426</b>	Noce ch.	10
<b>P1427</b>	Mogano	10
<b>P1428</b>	Rovere	10
<b>P1429</b>	Lacc. Bianco	10
<b>P1435</b>	Lacc. RAL9010	10
<b>P8429</b>	Grezzo	10

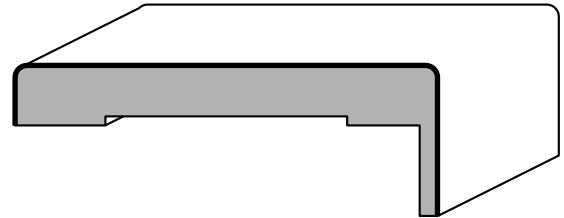

## Coprifilo telescopico Tanganika

mm 70x10/25x2250

Codice	Colore	Pz Conf
<b>P21003</b>	Grezzo	10

Sporgenza aletta mm 15

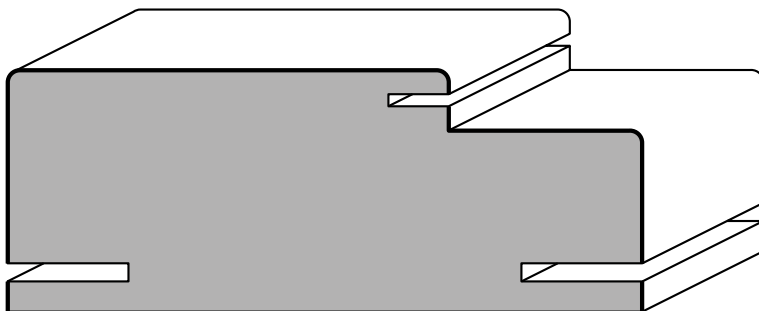

## Stipite per porte Tanganika

mm 40x105x2170

Codice	Colore	Pz Conf
<b>P21002</b>	Grezzo	4

Battuta mm 32

# Profili in Pino massello

P1

Pino di Svezia selezionato

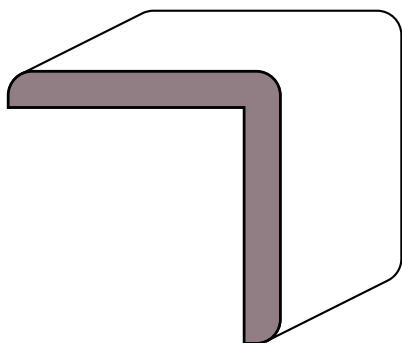

**Coprispigolo in Pino**  
mm 45x45x3000

Codice	Colore	Pz Conf
<b>P8020</b>	Grezzo	20

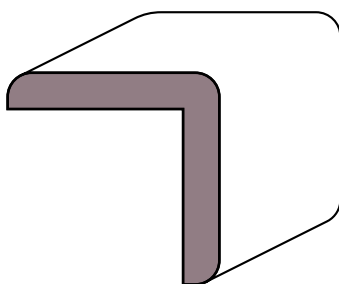

**Coprispigolo in Pino**  
mm 35x35x3000

Codice	Colore	Pz Conf
<b>P8016</b>	Grezzo	20

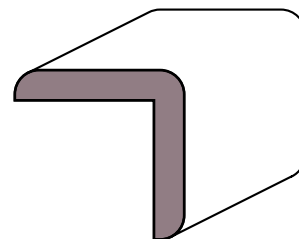

**Coprispigolo in Pino**  
mm 28x28x3000

Codice	Colore	Pz Conf
<b>P8017</b>	Grezzo	20

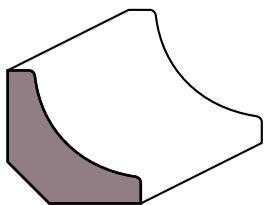

**Angolare in Pino**  
mm 28x13x3000

Codice	Colore	Pz Conf
<b>P8100</b>	Grezzo	20

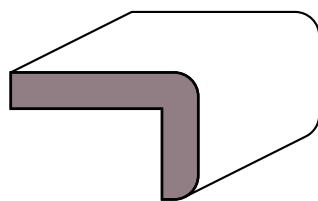

**Terminale in Pino**  
mm 32x20x3000  
interno mm 25x10

Codice	Colore	Pz Conf
<b>P8909</b>	Grezzo	20

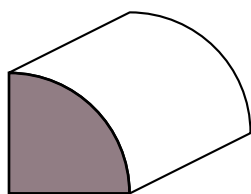

**Quarto di tondo in Pino**  
mm 20x20x3000

Codice	Colore	Pz Conf
<b>P8906</b>	Grezzo	20

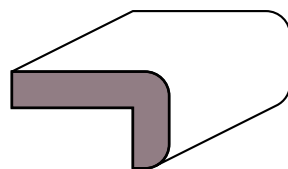

**Terminale in Pino**  
mm 26x20x3000  
interno mm 20x10

Codice	Colore	Pz Conf
<b>P8907</b>	Grezzo	20

Esempi di montaggio con perlinato:

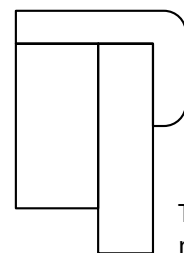

Terminale  
mm 32x20

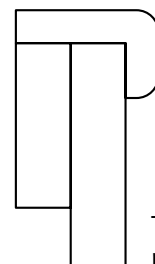

Terminale  
mm 26x20



# Profili in Pino massello

P1

Pino di Svezia selezionato

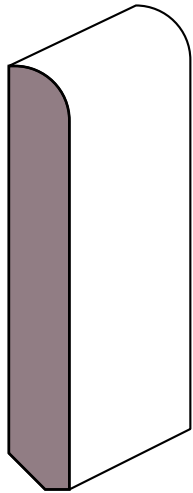

**Battiscopa in Pino**  
mm 70x10x2100

Codice	Colore	Pz Conf
<b>P8011</b>	Grezzo	10

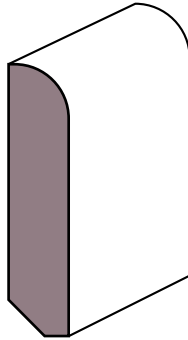

**Battiscopa in Pino**  
mm 45x10x2100

Codice	Colore	Pz Conf
<b>P8010</b>	Grezzo	10

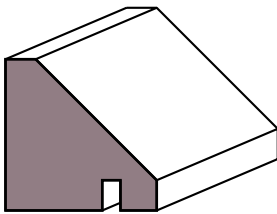

**Gocciolatoio per infissi**  
mm 25x25x3000

Codice	Colore	Pz Conf
<b>P8993</b>	Grezzo	10

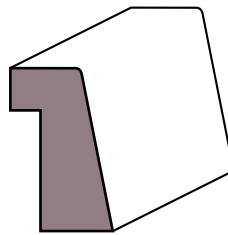

**Fermavetro in Pino**  
mm 24x14x3000

Codice	Colore	Pz Conf
<b>P8009</b>	Grezzo	20

Interno mm 18x6



**Mostrina per finestre**  
mm 45x10x3000

Codice	Colore	Pz Conf
<b>P8021</b>	Grezzo	20

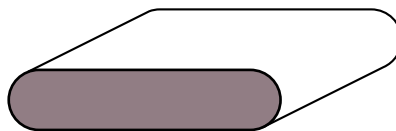

**Lamella per persiane**  
mm 45x10x3000

Codice	Colore	Pz Conf
<b>P8022</b>	Grezzo	20

## PERLINATO IN ABETE

Doghe ad incastro per rivestimento in Abete Massello



### SUPERIOR

**Perlinato in Abete mm 100x13**

**Pacco da 5 aste**

Larghezza nominale mm 100

Larghezza effettiva mm 92

Resa mm 81

Codice	Dimensioni mm	Descrizione	mq/pacco
7745	100x13x2000	Grezzo	1,90

Listelli per sottostruttura nella sezione listelli piallati in abete  
I codici si riferiscono al pacco e non alla singola asta

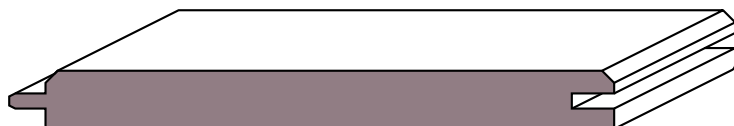

### BASIC

**Perlinato in Abete mm 100x10**

**Pacco da 10 aste**

Larghezza nominale mm 100

Larghezza effettiva mm 92

Resa mm 81

Codice	Dimensioni mm	Descrizione	mq/pacco
7750	100x10x2000	Grezzo	1,90
7743	100x10x3000	Grezzo	2,85
7740	100x10x3000	Noce	2,85
7741	100x10x3000	Miele	2,85
7742	100x10x3000	Naturale	2,85

Listelli per sottostruttura nella sezione listelli piallati in abete  
I codici si riferiscono al pacco e non alla singola asta

# LISTONE DOPPIO USO IN ABETE

96

Doghe ad incastro per pavimenti e sottotetti in Abete Massello



Lato per sottotetto



Lato per pavimenti

## LISTONE DOPPIO USO IN ABETE

**Per pavimenti e sottotetti mm 120x20**

**Pacco da 5 aste**

Larghezza nominale mm 120

Larghezza effettiva mm 115

Spessore effettivo mm 18

Resa mm 105

Codice	Dimensioni mm	Descrizione	mq/pacco
7746	120x20x3000	Grezzo	1,55
7612	120x20x2000	Grezzo	1,05

Listelli per sottostruttura nella sezione listelli piallati in abete  
I codici si riferiscono al pacco e non alla singola asta

# PAVIMENTO LARICE DECKING

96

Listone per pavimenti per esterno in Larice Siberiano  
Un lato liscio levigato e un lato zigrinato  
Posa con viti in acciaio inox su sottostruttura in legno

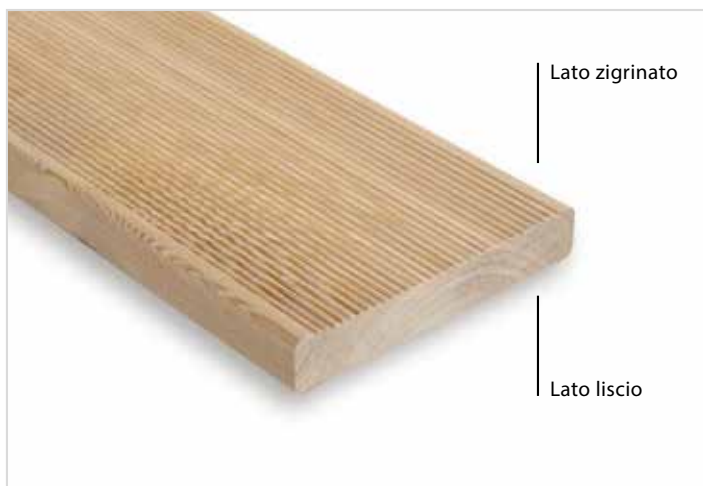

## LISTONE DECKING IN LARICE GREZZO LEVIGATO

Posa con viti

Codice	Dimensioni nominali mm	Ordine min pz
--------	------------------------	---------------

7782	145x24x2000	5
7781	145x24x4000	100

Listelli per sottostruttura nella sezione listelli piallati in abete  
I codici si riferiscono al pacco e non alla singola asta

## VITI SPAX® IN ACCIAIO INOX A2 Impronta Torx con doppia filettatura

Codice	Dim. mm	Confezione
--------	---------	------------

7785	50x5	Scatola da 150 viti
7786	60x5	Scatola da 125 viti



**Questa vite è stata progettata per il montaggio permanente di pavimentazioni in legno per esterno specialmente di tipo decking.**

- ✓ Doppio filetto per garantire un fissaggio duraturo tra listone e sottostruttura in legno.
- ✓ Punta "Cut" che permette di avvitare senza screpolare il legno.
- ✓ Filettatura ampia e ondulata per velocizzare la posa della pavimentazione.
- ✓ Acciaio Inox AISI 304 A2 per una elevata resistenza alla ruggine anche in situazioni limite.
- ✓ Qualità "Made in Germany"

## PVC

PV

Battiscopa e coprispighi in PVC rigido estruso

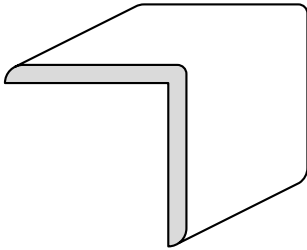

**Coprispigholo PVC**  
mm 30x30x3000

Codice	Colore	Pz Conf
<b>P5064</b>	Noce scuro	10
<b>P5065</b>	Bianco	10
<b>P5066</b>	Nero	10

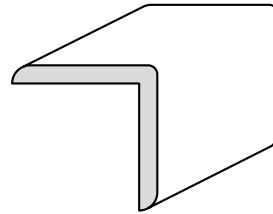

**Coprispigholo PVC**  
mm 25x25x3000

Codice	Colore	Pz Conf
<b>P5071</b>	Bianco	10
<b>P5072</b>	Nero	10

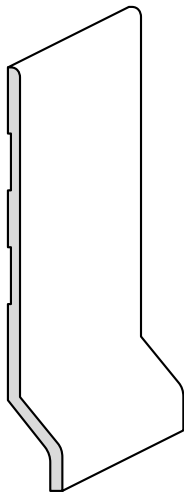

**Battiscopa PVC**  
mm 70x10x2000

Codice	Colore	Pz Conf
<b>P5005</b>	Noce scuro	20
<b>P5006</b>	Bianco	20
<b>P5007</b>	Nero	20
<b>P5020</b>	Grigio chiaro	20

Gamma colori

Noce  
scuroGrigio  
chiaro

Bianco

Nero

# SALVAPARETI

24

Soluzioni per la protezione di muri

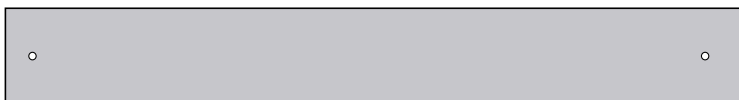

## Salvaparete in pvc con fori di montaggio

mm 80x5x800

Codice	Colore	Descrizione	Conf
<b>1402</b>	Trasparente	Sfuso	50
<b>14021</b>	Trasparente	Blister singolo	10



Cod. 1403

Cod. 1401

## Sottointerruttori in pvc trasparente

mm 180x150

Codice	Descrizione	Conf
<b>1401</b>	Sfuso in scatola	10
<b>1403</b>	Sfuso in scatola	10

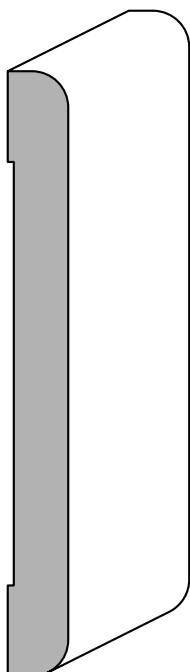

## Salvaparete in Ayous

mm 100x10x2400

Codice	Colore	Conf
<b>P1506</b>	Lacc. Bianco	10
<b>P1509</b>	Grezzo	10